

Ripartitori – Tipo M, P, L, N (alluminio)

Uscita unilaterale

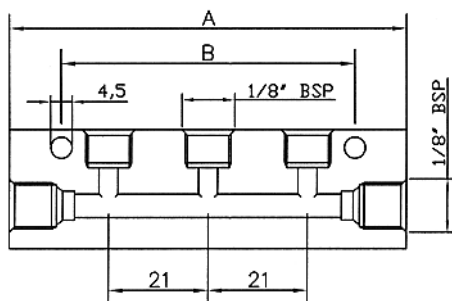

Uscita bilaterale

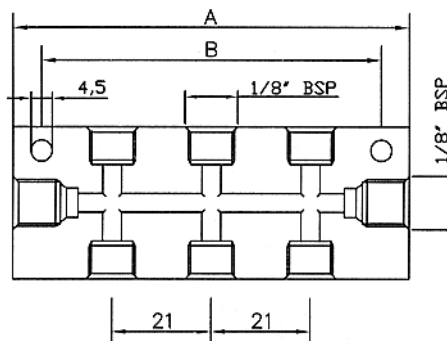

Per montaggio con valvole da 0,03 – 0,50 cc/min

RIPARTITORE TIPO: M

N. di uscite	Codice	Fissaggio		Peso	Dis. sezione
		A	B		
1	6265	40	20	21	
2	6266	61	41	33	
3	6267	82	62	44	
4	6268	103	83	58	
5	6269	124	104	68	
6	6274	145	125	80	
7	6276	166	146	92	
8	6239	187	167	104	

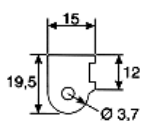

RIPARTITORE TIPO: P

N. di uscite	Codice	Fissaggio		Peso	Dis. sezione
		A	B		
2	6236	40	20	28	
4	6237	61	41	41	
6	6238	82	62	60	
8	6188	103	83	71	
10	6189	124	104	90	
12	6210	145	125	101	

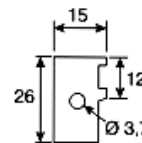

Per montaggio con valvole da 0,03 – 1,00 cc/min

RIPARTITORE TIPO: L

N. di uscite	Codice	Fissaggio		Peso	Dis. sezione
		A	B		
1	3071311	42	20	30	
2	3071312	63	41	63	
3	3071313	84	62	96	
4	3071314	105	83	120	
5	3071315	126	104	146	
6	3071316	147	125	169	

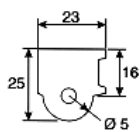

RIPARTITORE TIPO: N

N. di uscite	Codice	Fissaggio		Peso	Dis. sezione
		A	B		
2	3071322	42	30	90	
4	3071324	63	51	120	
6	3071326	84	72	140	
8	3071328	105	93	180	

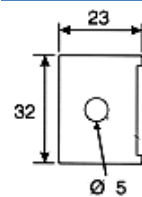

Profilati in barre estruse (per realizzare ripartitori personalizzati)

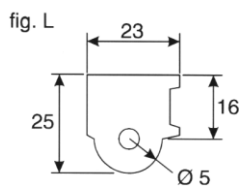

5422810
kg. 1,225

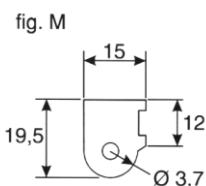

5422800
kg. 0,650

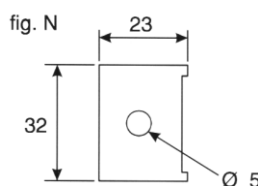

5422811
kg. 1,900

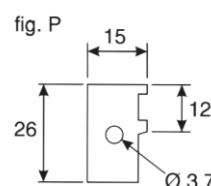

5422801
kg. 0,930