

## DPP DOUBLE DIAPHRAGM PUMPS 110-700



**FEATURES**

- Made of ALUMINIUM
- Compression ratio = 1:1
- Max flow-rate = 110 l/min
- Fluid connections = 3/4" BSP



EX II 3/3 GD h IIB T4 135°C ATEX zone2

General Technical Features	
Fluid connections	3/4" BSP
Air connection	3/8" BSP
Max flow-rate	100 l/min
Max air pressure	8 bar
Max delivery head	80 m
Max Suction Lift Dry	5,0 m
Max Suction Lift Wet	9,8 m
Max Solid passing	4 mm
Noise level	72 db
Displacement per cycle	200 cm <sup>3</sup>
Max Viscosity	25000 cps

**Performance**

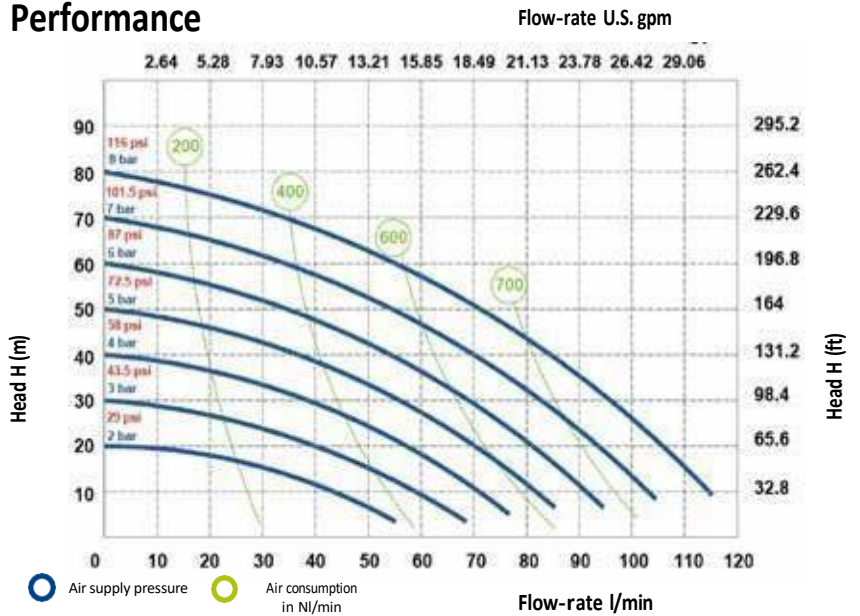

The curves and performance values refer to pumps with submerged suction and a free delivery outlet with water at 20°C and vary according to the construction material.

Dimensions	
A (mm)	265
B (mm)	178
C (mm)	245
Gross weight (kg)	6,0
Max temperature (°C)	-20°C + 95°C

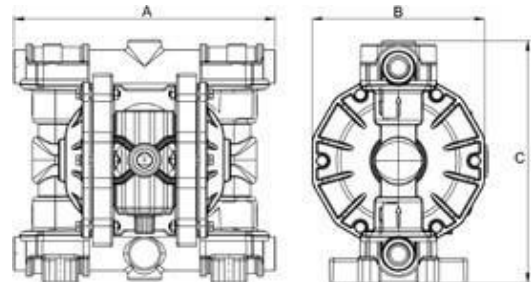

PART NUMBER	CASING	DIAPHRAGM	BALLS	GASKET	FLUIDS
1230901	ALUMINIUM	HYTREL	SS AISI 316	NBR	oil-exhausted oil-diesel fuel
1230902	ALUMINIUM	HYTREL+PTFE	PTFE	VITON	water-anti-freeze-windscreen
1230903	ALUMINIUM	HYTREL+PTFE	PTFE	PTFE	aggressive fluids (acids and basics)
1230904	ALUMINIUM	SANTOPRENE	EPDM	EPDM	abrasive liquids - alkaline/basic

**FEATURES**

- Made of ALUMINIUM
- Compression ratio = 1:1
- Max flow-rate = 170 l/min
- Fluid connections = 1" BSP



EX II 3/3 GD h IIB T4 135°C ATEX zone2

General Technical Features	
Fluid connections	1" BSP
Air connection	1/2" BSP
Max flow-rate	170 l/min
Max air pressure	8 bar
Max delivery head	80 m
Max Suction Lift Dry	5,0 m
Max Suction Lift Wet	9,8 m
Max Solid passing	7,5 mm
Noise level	75 db
Displacement per cycle	700 cm <sup>3</sup>
Max Viscosity	35000 cps

**Performance**

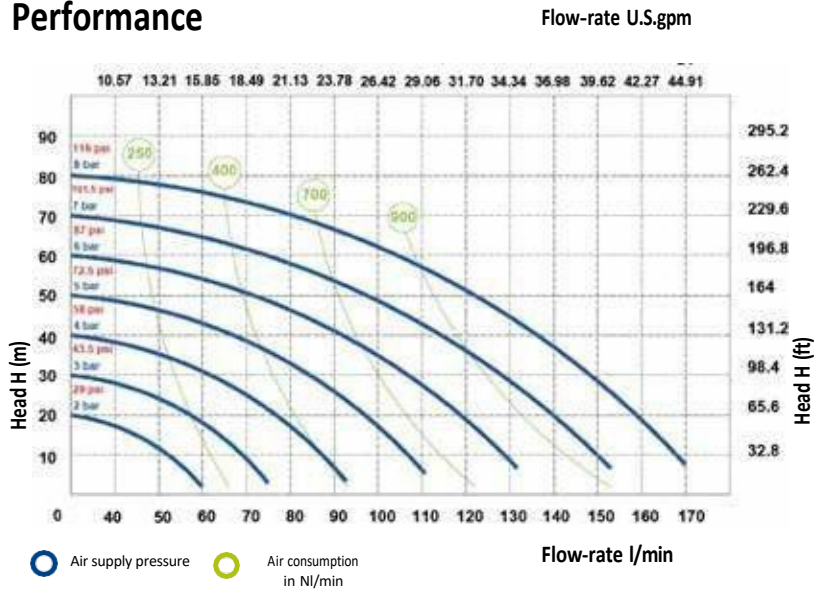

The curves and performance values refer to pumps with submerged suction and a free delivery outlet with water at 20°C and vary according to the construction material.

Dimensions	
A (mm)	370
B (mm)	222
C (mm)	364
Gross weight (kg)	18,31
Max temperature (°C)	-20°C + 95°C

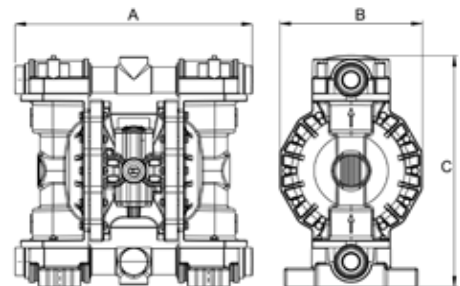

PART NUMBER	CASING	DIAPHRAGM	BALLS	GASKET	FLUIDS
1230905	ALUMINIUM	HYTREL	SS AISI 316	NBR	oil-exhausted oil-diesel fuel
1230906	ALUMINIUM	HYTREL+PTFE	PTFE	VITON	water-anti-freeze-windscreen
1230907	ALUMINIUM	HYTREL+PTFE	PTFE	PTFE	aggressive fluids (acids and basics)
1230908	ALUMINIUM	SANTOPRENE	EPDM	EPDM	abrasive liquids - alkaline/basic

**FEATURES**

- Made of ALUMINIUM
- Compression ratio = 1:1
- Max flow-rate = 250l/min
- Fluid connections = 1.1/4 BSP



EX II 3/3 GD h IIB T4 135°C ATEX zone2

General Technical Features	
Fluid connections	1.1/4" BSP
Air connection	1/2" BSP
Max flow-rate	250 l/min
Max air pressure	8 bar
Max delivery head	80 m
Max Suction Lift Dry	5,0 m
Max Suction Lift Wet	9,8 m
Max Solid passing	7,5 mm
Noise level	75 db
Displacement per cycle	700 cm <sup>3</sup>
Max Viscosity	35000 cps

**Performance**

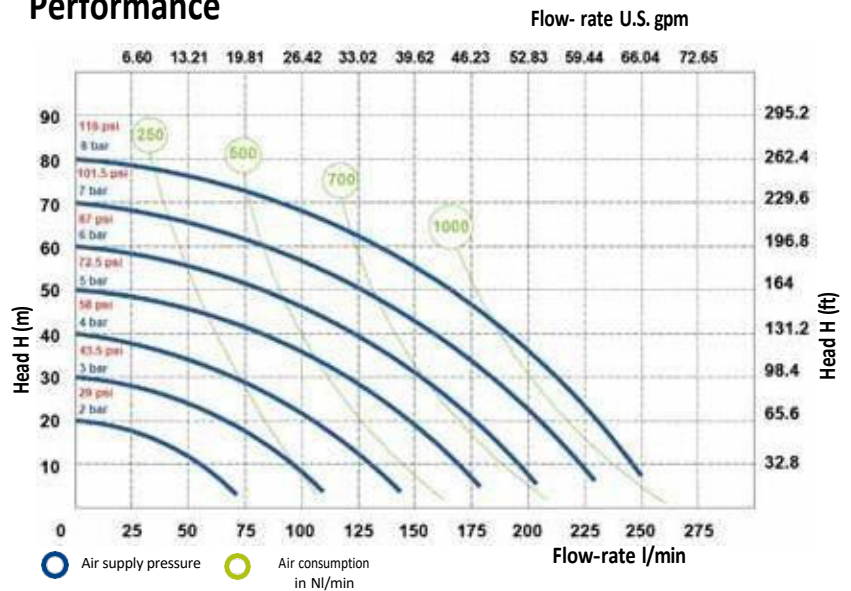

The curves and performance values refer to pumps with submerged suction and a free delivery outlet with water at 20°C and vary according to the construction material.

Dimensions	
A (mm)	370
B (mm)	222
C (mm)	364
Gross weight (kg)	13,4
Max temperature (°C)	-20°C + 95°C

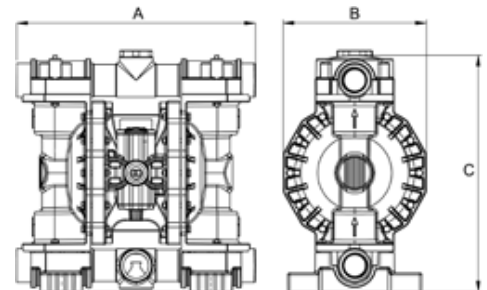

PART NUMBER	CASING	DIAPHRAGM	BALLS	GASKET	FLUIDS
1230909	ALUMINIUM	HYTREL	SS AISI 316	NBR	oil-exhausted oil-diesel fuel
1230910	ALUMINIUM	HYTREL+PTFE	PTFE	VITON	water-anti-freeze-windscreen
1230911	ALUMINIUM	HYTREL+PTFE	PTFE	PTFE	aggressive fluids (acids and basics)
1230912	ALUMINIUM	SANTOPRENE	EPDM	EPDM	abrasive liquids - alkaline/basic



**FEATURES**

- Made of ALUMINIUM
- Compression ratio = 1:1
- Max flow-rate = 400 l/min
- Fluid connections = 1.1/2" BSP

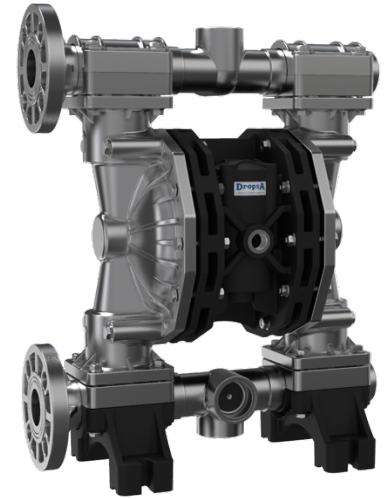

EX II 3/3 GD h IIB T4 135°C ATEX zone2

General Technical Features	
Fluid connections	1.1/2" BSP
Air connection	1/2" BSP
Max flow-rate	400 l/min
Max air pressure	8 bar
Max delivery head	80 m
Max Suction Lift Dry	5,0 m
Max Suction Lift Wet	9,8 m
Max Solid passing	8 mm
Noise level	78 db
Displacement per cycle	1200 cm <sup>3</sup>
Max Viscosity	40000 cps

**Performance**

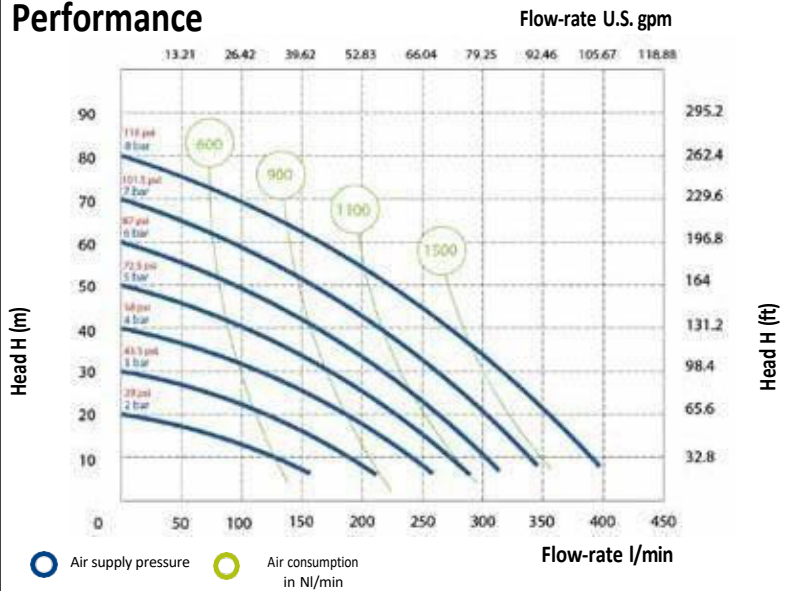

The curves and performance values refer to pumps with submerged suction and a free delivery outlet with water at 20°C and vary according to the construction material.

Dimensions	
A (mm)	445
B (mm)	260
C (mm)	563
Gross weight (kg)	24,8
Max temperature (°C)	-20°C + 95°C

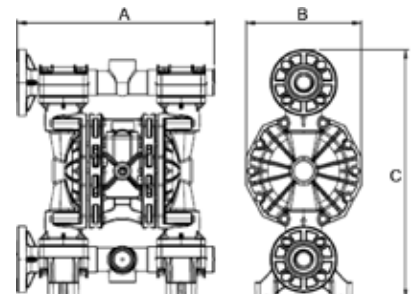

PART NUMBER	CASING	DIAPHRAGM	BALLS	GASKET	FLUIDS
1230913	ALUMINIUM	HYTREL	SS AISI 316	NBR	oil-exhausted oil-diesel fuel
1230914	ALUMINIUM	HYTREL+PTFE	PTFE	VITON	water-anti-freeze-windscreen
1230915	ALUMINIUM	HYTREL+PTFE	PTFE	PTFE	aggressive fluids (acids and basics)
1230916	ALUMINIUM	SANTOPRENE	EPDM	EPDM	abrasive liquids - alkaline/basic

**FEATURES**

- Made of ALUMINIUM
- Compression ratio = 1:1
- Max flow-rate = 700 l/min
- Fluid connection = 2" BSP



EX II 3/3 GD h IIB T4 135°C ATEX zone2

General Technical Features	
Fluid connections	2" BSP
Air connection	3/4" BSP
Max flow-rate	700 l/min
Max air pressure	8 bar
Max delivery head	80 m
Max Suction Lift Dry	5,0 m
Max Suction Lift Wet	9,8 m
Max Solid passing	8,5 mm
Noise level	78 db
Displacement per cycle	3050 cm <sup>3</sup>
Max Viscosity	50000 cps

**Performance**

Flow-rate U.S. gpm



Air supply pressure Air consumption in NI/min

The curves and performance values refer to pumps with submerged suction and a free delivery outlet with water at 20°C, and vary according to the construction material.

Dimensions	
A (mm)	595
B (mm)	345
C (mm)	567
Gross weight (kg)	41,73
Max temperature (°C)	-20°C + 95°C

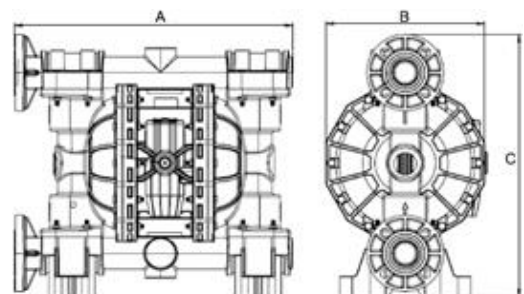

PART NUMBER	CASING	DIAPHRAGM	BALLS	GASKET	FLUIDS
1230917	ALUMINIUM	HYTREL	SS AISI 316	NBR	oil-exhausted oil-diesel fuel
1230918	ALUMINIUM	HYTREL+PTFE	PTFE	VITON	water-anti-freeze-windscreen
1230919	ALUMINIUM	HYTREL+PTFE	PTFE	PTFE	aggressive fluids (acids and basics)
1230920	ALUMINIUM	SANTOPRENE	EPDM	EPDM	abrasive liquids - alkaline/basic

C2330PE WK 30/23

DropsA products can be purchased at DropsA branches and authorised distributors. Go to [www.dropsa.com/contact](http://www.dropsa.com/contact) or write to [sales@dropsa.com](mailto:sales@dropsa.com)

Distributor info: