

CHARACTERISTICS

- **OPERATING PRESSURE**
max. 400 bar
min. 20 bar;
- **OPERATING PRESSURE FOR RECIRCULATION SYSTEMS WITHOUT OUTLET VALVES:**
min. 12 bar;
- **NUMBER OF INVERSIONS PER MINUTE:**
max. 120;
- **Tightening torque of rods**
max. 3kgm.

“SA” Series divider elements

Progressive divider elements with a steel body, tempered piston, heavy-duty ring seal, device for uniting or separating the outlets.

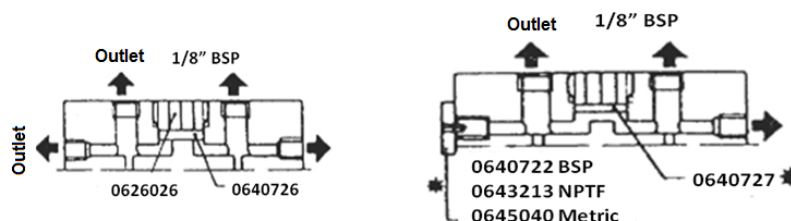

* Order separately

Outlet

For perfect operation, ensure that the group is completely flushed with air. Otherwise adjust the bleed valves located on both sides of the end element.

It is possible to double the flow rate by replacing the gasket with the Part Number 640726 with the gasket with the Part number 640727 as illustrated in the diagram.

The upper outlets are 1/8 BSP threaded, even in the case of the version with a metric threading.

TECHNICAL CHARACTERISTICS

Individual outlet flow	From 0.5 cm ³ (0.03 cu.in.) to 5 cm ³ (0.3 cu.in.)
Number of divider elements	3 ÷ 10
Max. operating pressure	20 bar (290psi) ÷ 400bar (5802psi)
Tightening torque of rods	Max. 3kgm
Material	Nickel-plated steel
Number of rotations per minute	120 max.
Inbound thread	3/8" BSP – 3/8" NPTF – M18x1.5
Outlet thread	1/4" BSP – 1/4 NPTF – M14x1.5
Lubricants	Min. Oil. 32 cSt - max. 2 NLGI grease

DIMENSIONS (DRAWING NOT TO SCALE)

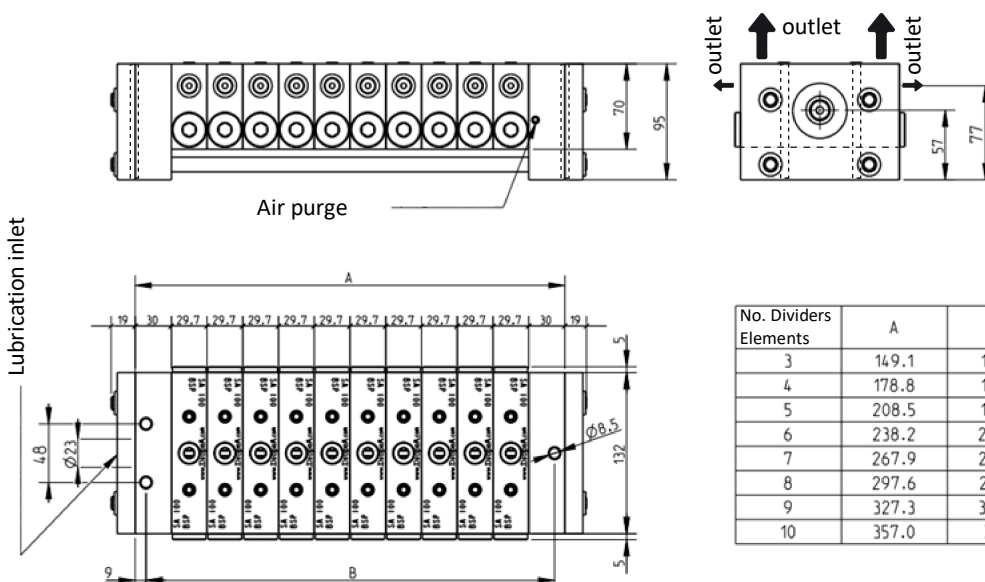

No. Dividers Elements	A	B
3	149.1	131.6
4	178.8	161.3
5	208.5	191.0
6	238.2	220.7
7	267.9	250.4
8	297.6	280.1
9	327.3	309.8
10	357.0	339.5

APPLICATIONS

- USED IN RECIRCULATING SYSTEMS
- e.g.: APPLICATIONS ON LARGE-SCALE PRESSES



SYSTEM CONFIGURATION ELEMENTS

MONITORING DEVICES

Monitoring of rotation control using a micro-contact

A micro-switch with a communication contact is controlled by an articulated rod, joint with divider element piston. This device is suitable for the control of the lubrication cycle at predefined intervals. Characteristics of the contact: Max. 220 V, 50-60 Hz -5 A

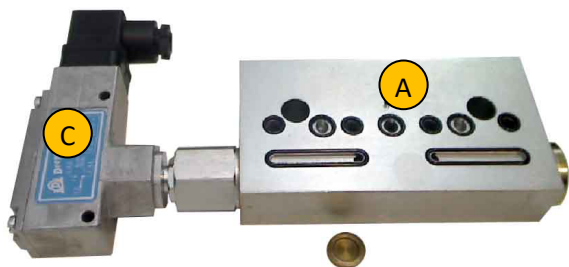

OUTLETS	PART NUMBER					
	a			A+C		
	1.5 cc. .09 cu.in.	3 cc. .18 cu.in.	4.5 cc. .27 cu.in.	1.5 cc. .09 cu.in.	3 cc. .18 cu.in.	4.5 cc. .27 cu.in.
BSP	0644164	0644165	0644166	0644182	0644183	0644184
NPTF	0643359	0643360	0643361	0643377	0643378	0643379

Monitoring of rotation control using a magnetic contact

A permanent magnet applied to the piston triggers a “reed” contact which, if connected to an electronic counter, can view up to 500 movement. The “reed” contact is inserted into a sealed container and it can be replaced easily. The divider element complete with such a device if fixed to a metallic mass, must be at a distance of at least 10 mm. (.39 in.). It is better to apply with the device at the top and the outlets on the bottom. Characteristics of the contact: Max. 220 V 50-60 Hz – 0.8 A

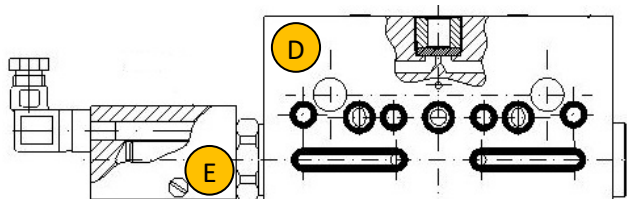

OUTLETS	PART NUMBER					
	D			D+E		
	1.5 cc. .09 cu.in.	3 cc. .18 cu.in.	4.5 cc. .27 cu.in.	1.5 cc. .09 cu.in.	3 cc. .18 cu.in.	4.5 cc. .27 cu.in.
BSP	0644191	0644192	0644193	0644200	0644201	0644202
NPTF	0643386	0643387	0643388	0643395	0643396	0643397

Visual inspection

can be performed as an alternative to view or use the piston pin piston movement.



OUTLETS	PART NUMBER					
	A			A+C		
	1.5 cc. .09 cu.in.	3 cc. .18 cu.in.	4.5 cc. .27 cu.in.	1.5 cc. .09 cu.in.	3 cc. .18 cu.in.	4.5 cc. .27 cu.in.
BSP	0644164	0644165	0644166	0644173	0644174	0644175
NPTF	0643359	0643360	0643361	0643368	0643369	0643370





SYSTEM CONFIGURATION ELEMENTS





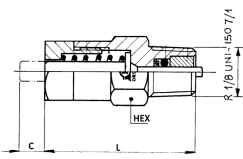
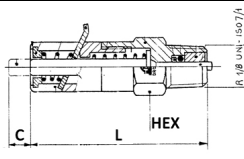



Visual inspection

can be performed as an alternative to view or use the piston pin piston movement.

CHARACTERISTICS			 NORMAL (N)				 WITH MEMORY (M)				 WITH MEMBRANE (P)		
THREAD	MAXIMUM PRESSURE BAR	COLOUR OF THE ROD OR THE MEMBRANE	CH.	L	C. MAX.	PART NUMBER	CH.	L	C. MAX.	PART NUMBER	CH.	L	PART NUMBER
BSP 1/8 Silver Colour	20	Blue	12	31.5	5	3290019	12	44	5	-	14	28.5	-
	30	Silver				3290006				3290012			
	50	Red				3290007				-			
	50	Bronze				-				3290013			
	75	White				-				-			
	100	Yellow				3290008				3290014			
	150	Black				3290009				3290015			
	200	Green				3290010				3290016			
	250	Light blue				3290011				3290017			

ORDER INFORMATION

Use the below table to search in the price list for groups that are already assembled. The corresponding assembly comprises an initial element, divider elements, an end element, rod with nuts and washers.

PART NUMBER TABLE									
PIN	WASHER	ROD		INITIAL ELEMENT		DIVIDER		END ELEMENT	
									
8	8	4		1		Max. 10		1	
PART NUMBER	PART NUMBER	* NUMBER OF ELEMENTS	PART NUMBER	PART NUMBER		CC quantity	PART NUMBER		PART NUMBER
0049031	0016087	3	0640728	0640655	0643096	0.5	0644150	0643450	0640657
		4	0640729				0644151	0643451	
		5	0640730				0644152	0643452	
		6	0640731				0644153	0643453	
		7	0640732				0644154	0643454	
		8	0640733				0644155	0643455	
		9	0640734				0644156	0643456	
		10	0640735				0644157	0643457	
							0644158	0643458	
							0644159	0643459	

SPARE PARTS - COMPLETE SERIES OF O-RINGS FOR	PART NUMBER
Inlet element	0640813
Initial element	640813
Divider elements	640812
End element, no ring seal	640918
Initial Viton elements	-
Viton divider elements	640919
Ultrasensor	1655370

CONNECTION ELEMENT



FITTING								BRIDGE JUNCTIONS									
THREAD	A	B	C	CH.	L	PIPE SEAT Ø	PART NUMBER	CH.	L	H	I	PART NUMBER	CH.	L	H	I	PART NUMBER
BSP Silver colour	1/4	1/8	1/4	17	46	8	0640479	19	60	22.5	29.7	0640039	19	60	34	-	0640057
NPTF Black colour	1/4	1/8	1/4	19	45	-	0640131	19	60	24.5	29.7	0643155	19	60	32	29.7	0643160

COMPOSITION OF SERIES "SA" DIVIDER ASSEMBLIES

Figure for the identification for all devices that can be used on an assembly composed of 10 metering elements
For a description of symbols, see the legend on the following page.

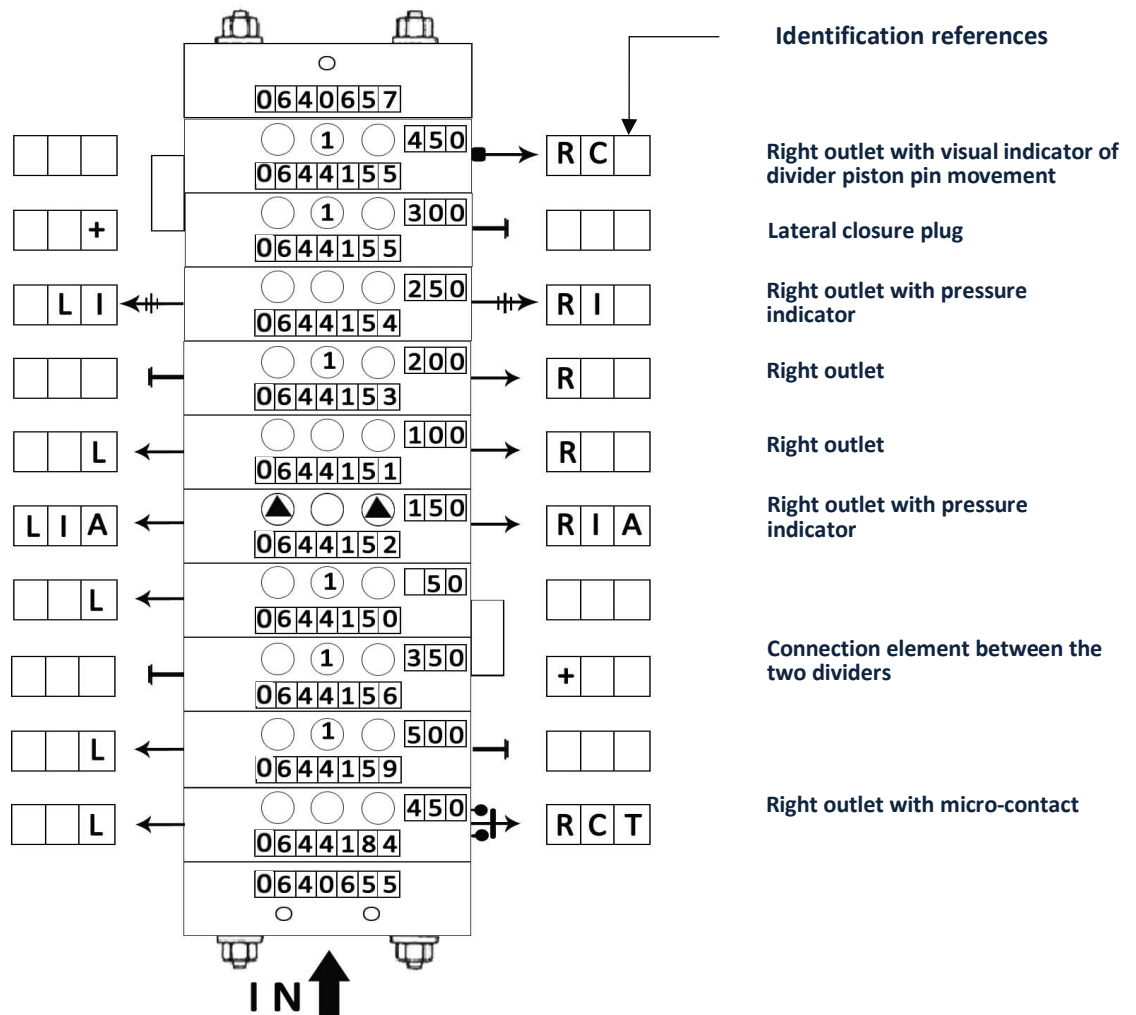

Note: The letter "R" indicates the assembly is on the right.

The letter "L" indicates that the assembly is on the left.

The group must be ordered even without specifying the individual part numbers, but by using only the identification references. In this case, the group will be identified as such:

□450LRCT □500L □350+50L □150LIARIA □100LR □200R □250LIRI □300+450RC

The + sign indicates that the two components are joined by a bridge junction.

Component identification number refers to the divider number indicated on the catalogue; with the value Q of the flow rate multiplied by 100.

e.g.: 150 corresponds to a System Configuration component with divider 1.5 cc.

MODULE TO SIMPLIFY THE PARTS LIST FOR ORDERING AN ASSEMBLY

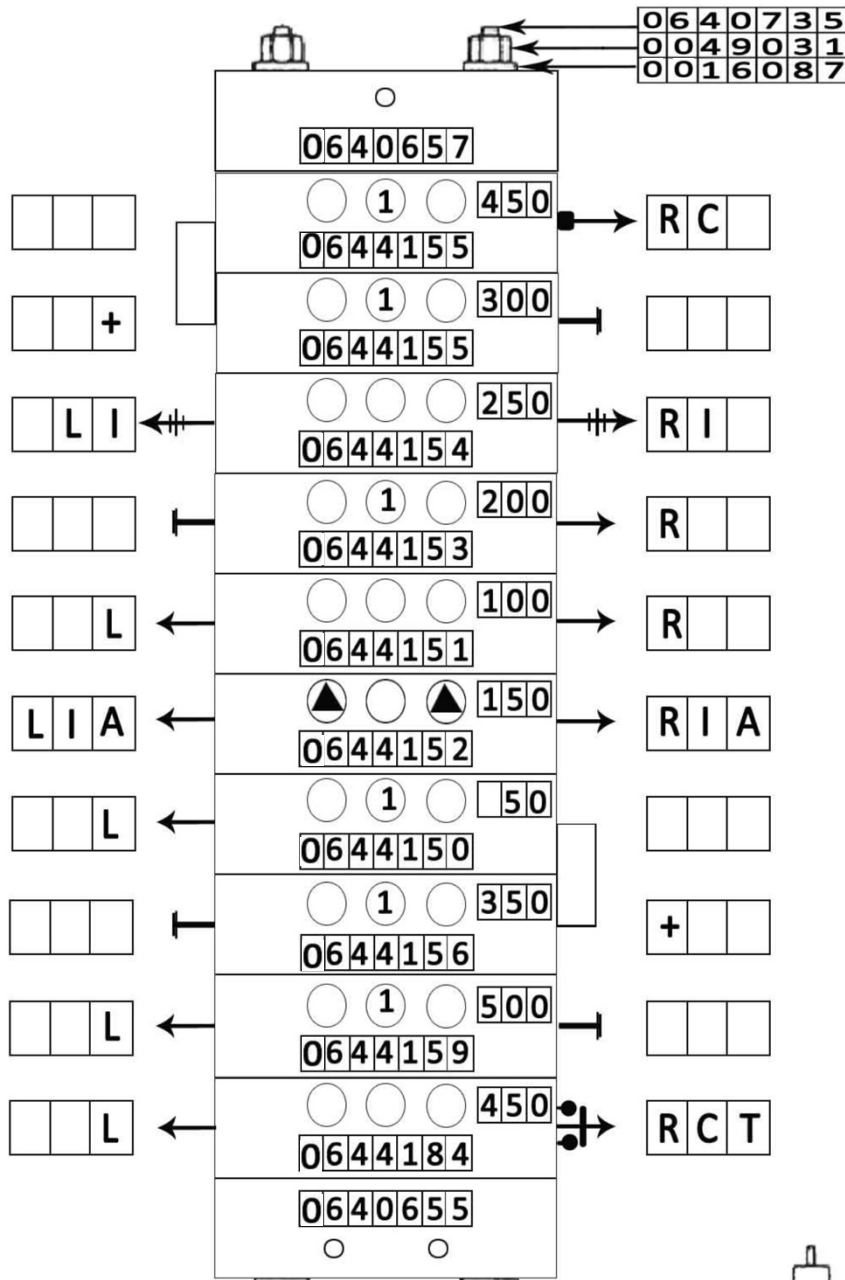

BOM components	
Quantity	PART NUMBER
1	0640655
1	0640657
4	0049031
4	0016087
2	0640735
1	0644175
1	0644184
1	0644159
1	0644156
1	0644150
1	0644152
1	0644151
1	0644153
1	0644154
1	0644155
2	0644033
2	3290001
4	0640722
6	0640727
2	0640039

CONNECTION ELEMENT

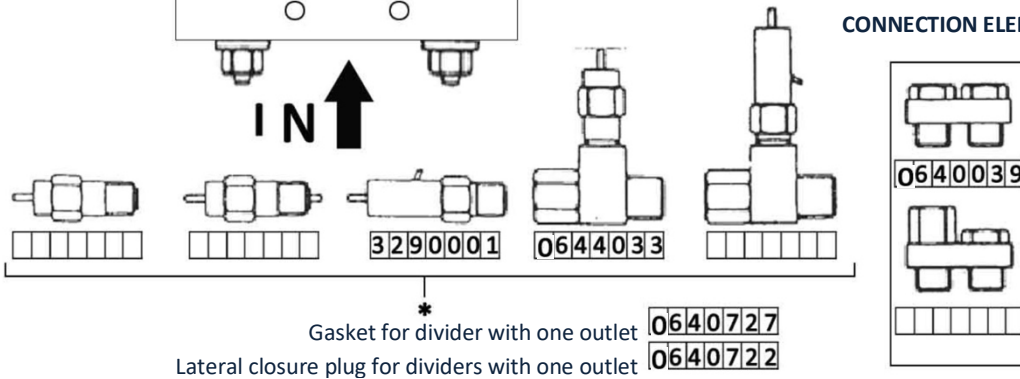

LEGEND					
	CT Micro-contact		+ Bridge junction	R Right outlet	
	CC Reed		I Pressure indicator	L Left outlet	
	C Rod		IA Pressure indicator		Lateral closure
	CP Ultrasensor				

Distributor info: